

INFAAB

2023 MINI CATALOG



PEACE OF MIND

In Radiation Protection

INFAB's R&D team continually strives to safeguard healthcare professionals from ionizing scatter radiation through providing top-of-the-line protective gear. Our commitment is to give healthcare professionals the assurance and peace of mind that comes from using our reliable and expertly crafted products.





Empowering Customers with Knowledge

INFAB is dedicated to providing our customers with accurate and comprehensive information about the materials and technology used in their radiation protective gear. We believe that this knowledge is crucial for making informed purchasing decisions and for understanding the level of protection being used.

Expert Support for Radiation Protection

Our dedicated global team of radiation protection experts is ready to provide friendly and efficient support throughout your experience with us. With years of industry experience, our specialists are well-equipped to assist with any questions you may have.



REVOLUTION APRONS

Our aprons are designed with the latest technology to protect you from radiation exposure and made from high-quality materials to ensure maximum durability and comfort.

Our Revolution line offers you a variety of styles and protection levels. You can add logos, monograms and design patterns to make it your own and reflect your unique style.

PARTIAL OVERLAP:

Full protection in each panel and double protection where the panels overlap in the front.

COLOR BLOCK DESIGN:

Exclusive Revolution color combination. Customization options available.

REVOLUTION FABRIC:

Lightweight, waterproof, abrasion resistant, flame resistant, and bacterial resistant.

SMART TRACK:

Web-based garment inspection tracking system.



All aprons are available in KIARMOR Bi-Layer Lead-Free and Lightweight Lead. KIARMOR is the only lead-free material that passes all three universally recognized testing procedures: ASTM F3094-14, IEC 61331-1:2014, DIN 6857-1.

903

Revolution
Reverse
Vest & Skirt
601 Black/Red



L103
Revolution Lumbar Vest & Skirt
711 White



203
Revolution Full Wrap Black Belt
602 Black/Fuchsia



303
Revolution Velcro Front
814 Jewelry Box Blue/White



403
Revolution Elastic Back Front
615 Black/Orange



503
Revolution Front Black Belt
504 Pink/Black



603
Revolution Elastic Black Full Wrap
612 Black / Ducks Green



703
Revolution Full Overlap Lumbar Vest & Skirt
505 Navy/Black



803
Revolution Black Belt Wrap
Remix Grey / Tide Red

REVOLUTION BASE APRONS

Revolution Base provides the same comfort and protection as our premium Revolution line, but in classic nylon colors and patterns. It does not include Revolution Fabric, Color-Blocking, or Cool-Wear.



BL103
Revolution Lumbar
Vest & Skirt Base
SH-23 Art Deco



B103
Revolution
Vest & Skirt Base
MIR280-09 Galaxy Black



B203
Revolution Full
Wrap Black Belt
Base
217 Mardi Gras



B303
Revolution
Front Base
207 Blue Flames



B403
Revolution Front
Elastic Back Base
184 Pink Camo



B503
Revolution Front
Black Belt Base
167 Cheetah



B603
Revolution Elastic
Back Full Wrap Base
SH-20 New Flames



REV-TC
Visor Style
Thyroid Collar

Velcro or Buckle
Closure



NST
Thyroid Collar
without Binding

Velcro, Buckle or
Magnet Closure

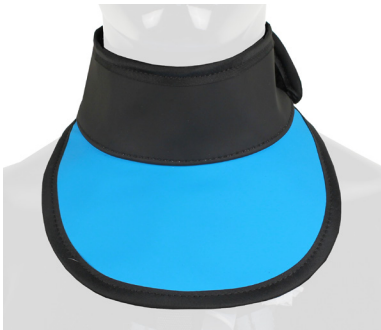

SVT
Visor Style
Thyroid Collar

Velcro or Buckle
Closure



TCV
Thyroid Collar
with Binding

Velcro, Buckle or
Magnet Closure

THYROID COLLARS

INFAB offers thyroid collars to protect against scatter radiation. Our collars can be attached to lead aprons. Choose from buckle, Velcro, or magnetic closures. Personalize with colors, patterns, monograms and logos.



MTC
Magnetic
Thyroid Collar
Magnet Closure

CLASSIC APRONS

The Infab Classic line of radiation protection lead aprons are available in a variety of styles. Choose from thousands of colors and patterns to make it your own. The aprons are made with standard lightweight nylon fabric and are fully customizable with colors, patterns, logos, and monograms.

STYLES:

Choose from thousands of colors and patterns.

MAKE IT YOUR OWN:

Fully customizable with colors, patterns, logos, and monograms.

NYLON FABRIC:

Standard lightweight nylon fabric.

SMART TRACK:

Web-based garment inspection tracking system.



VAS
Vest & Skirt
SH-4 Stylized
Hearts



All aprons are available in KIARMOR Bi-Layer Lead-Free and Lightweight Lead. KIARMOR is the only lead-free material that passes all three universally recognized testing procedures: ASTM F3094-14, IEC 61331-1:2014, DIN 6857-1.



MWA
Special Wrap
SH-7 Metallic
Splatter



FCW
Full Coat Wrap
120 Camouflage



WBT
2" Wide Belt
SH-12 Unicorn



SDA
**Surgery Drop
Off Shoulder
Release**
SH-10 Cats



RVAS
**Reverse Vest
& Skirt**
SH-8 Fish Bones



AWC
**Weight
Reliever**
SH-2 Blocks



EBA
Elastic Black
MIR280-09
Galaxy Black

GLASSES

Style + Protection

Our lead glasses are engineered to meet the industry standard of 0.75mm lead equivalency for the protective glass, providing you with the highest level of protection against harmful radiation beams.

These stylish and modern pieces are designed to withstand the daily rigors of your work and keep you safe. We provide you with the best quality radiation protection eyewear for your daily needs.

Complete line of Nike frames,
constantly updating.
Check for availability.



NIKE BRAZEN



GUCCI GG0343



NIKE BRAZEN FURY



NIKE PREMIER



NIKE 7117



NIKE 7118



NIKE MAVERICK RGE



FITOVERS



INCREDIBLES



EVO-01

RADIATION PROTECTION



SCATTER ARMOR

Shields & Drapes for Interventional Procedures

Prolonged low-dose exposure to scatter radiation can increase cancer risk for healthcare professionals. Scatter Armor shields and drapes reduce this risk by minimizing overall exposure.

“The scattered radiation from the patient comprises the main source of radiation dose to staff.”



IAEA
International Atomic Energy Agency

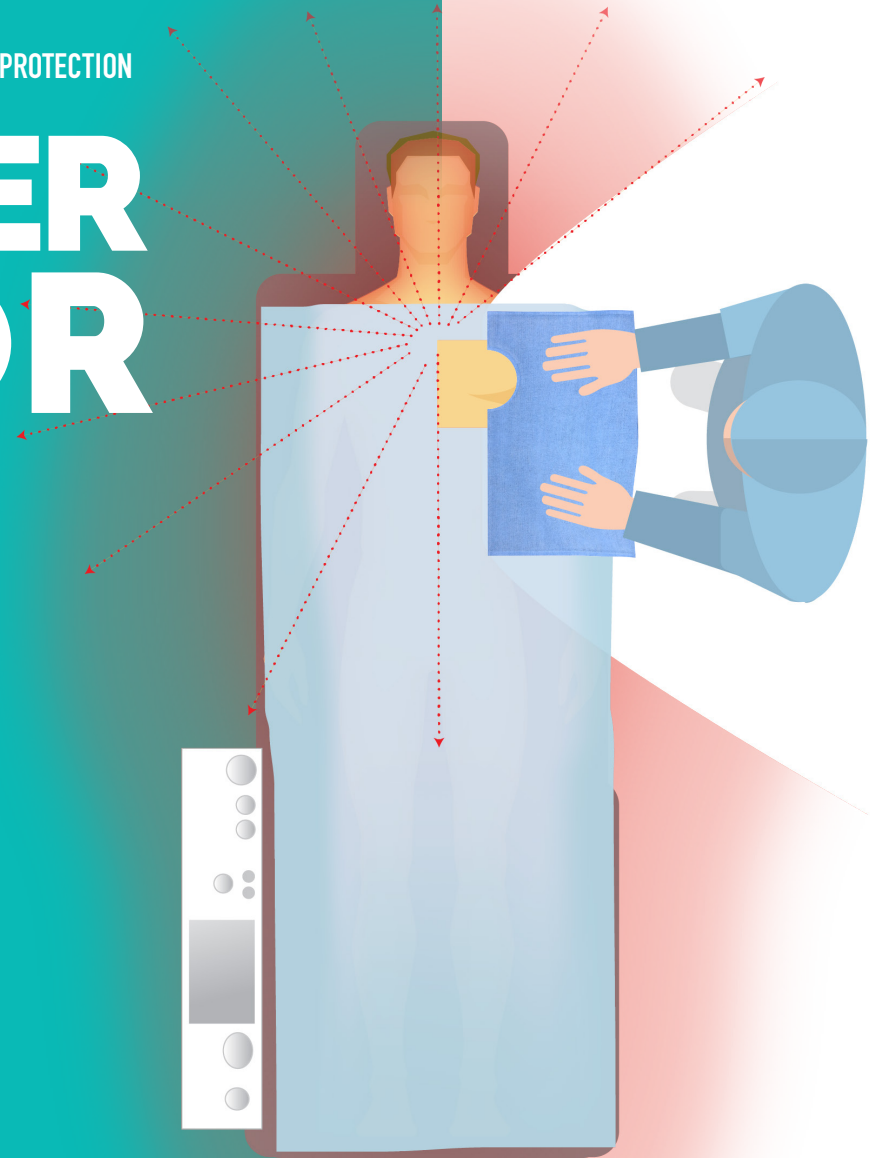

Scatter Protection

Scatter Armor Shields provide scatter radiation protection for radial and many other types of procedures. KIARMOR Bi-Layer is the most protective core material against scatter radiation.

SA-MPS Scatter Armor Multipurpose Shield

Transradial Access: Left and Right Radial, Shunt, Biliary Drainage, Spinal, Fibroid Embolization.

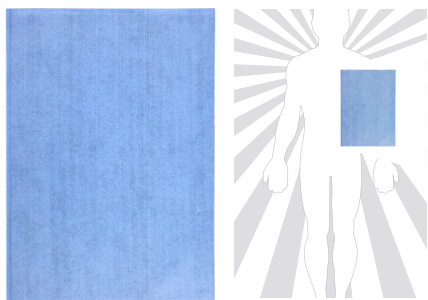

Absorbent

Scatter Armor Shields utilize the highest absorbency covering material in the industry, critical in heavy fluid situations.

SA-MPF Scatter Armor Multipurpose Shield with Fenestration

Needle Biopsy or Puncture Procedures.

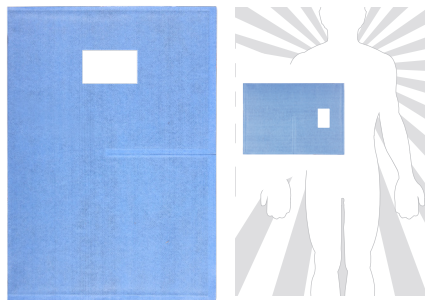

Flexible

Scatter Armor Shields easily mold to the patient's body for ease of use and maximum protection.

SA-EP Scatter Armor EP Shield

Subclavian Access: Bi-Ventricular Pacemaker Implants, ICS procedures, and Bi-Ventricular Pacing.

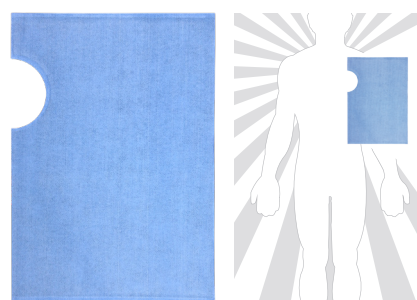

One-time Use

Scatter Armor Shields are lead-free and disposable.

Sterile

Packaged individually in sterile packets.

SA-AGS Scatter Armor Angiography Shield

Transfemoral Access: Angiography, Coronary Catheterization.

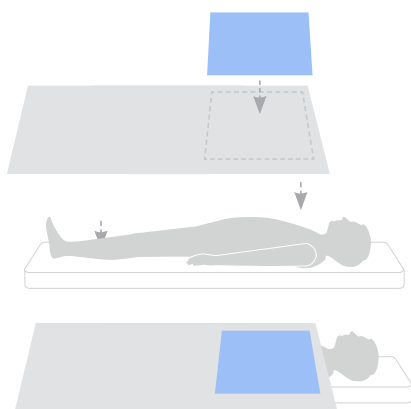
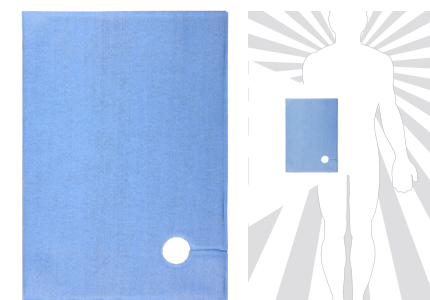

SA-BSS Scatter Armor Biliary Split Shield

Biopsy Procedures, Transjugular Intrahepatic Portosystemic Shunt (TIPS).

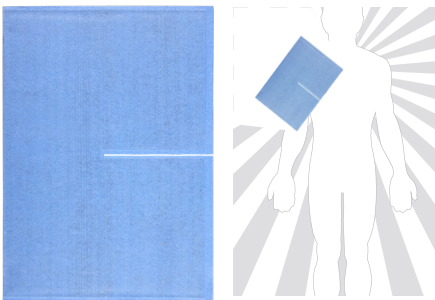

SA-PER Scatter Armor Peripheral Shield

Peripheral procedures where the access is through the femoral artery.

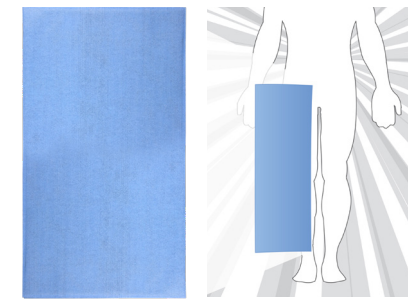

SA-DDD Scatter Armor Dialysis Drape

Dialysis Access and Declothing Procedures.

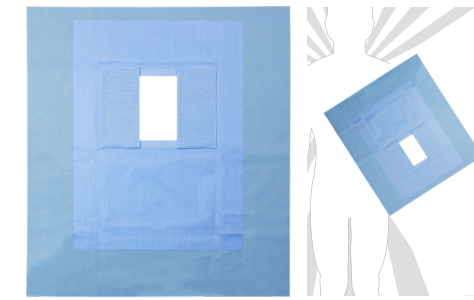

LOCKERS

Security + Protection

Our Revolution Lockers combine protection and security for your garments. They include a passcode encrypted keypad and durable frame for secure storage. The battery-operated passcode system allows for up to 3 admin codes.



REV-LOCKER-20
Revolution
20 Hanger Mobile
Apron Locker

REVOLUTION MOBILE APRON LOCKERS

- Features digital passcode locks with keypad
- Set up to 3 administrative and user passcodes
- Battery operated lock with backup battery and emergency power supply



REV-LOCKER-5
Revolution
5 Hanger Mobile
Apron Locker



(Black Shown)

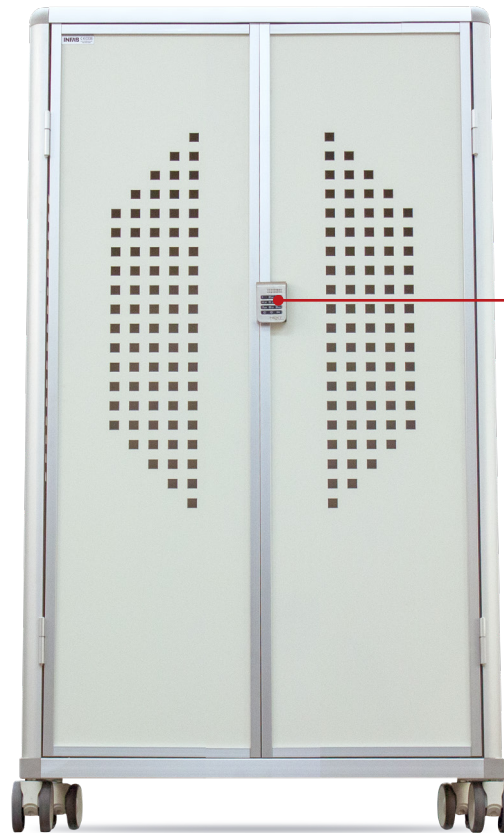

REV-LOCKER-10
Revolution
10 Hanger Mobile
Apron Locker



These Revolution Lockers are securely locked with a battery-operated passcode encrypted keypad that allows you to set up to 3 administrative codes.

BARRIERS

Mobility & Protection

Protect yourself from head-to-toe with any of our durable mobile barriers. Most of our barriers come equipped with the option of either an acrylic or a lead shield. Optional color, metal type, height, width, and window configurations available. INFAB's mobile barriers are guaranteed to make your life easier with its convenient mobility, and easy-to-clean features.



EVO-460
Flat-Pack Barrier



683461
Tilted Mobile
Barrier

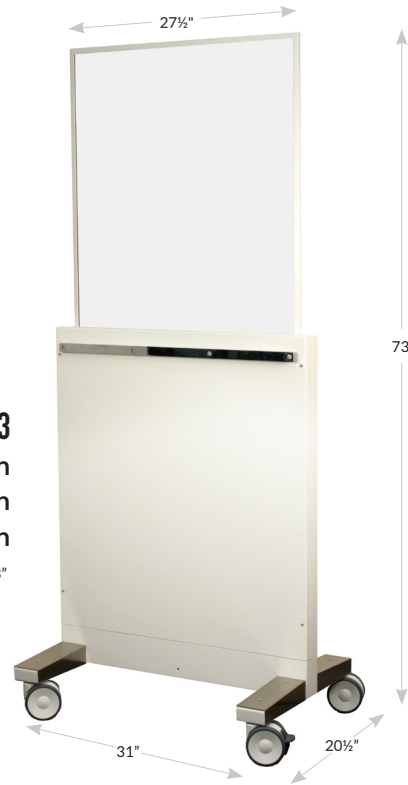

076993
Technician
Protection
Mobile Screen
Adjustable from 44" to 73"



REV-SPMC
Revolution Solid
Panel Mobile Curtain



683495
Adjustable Height
Wraparound Barrier



REV-PMC
Revolution Mobile
Curtain
Adjustable from 43.5" to 66"



076994
Physician Protection
Mobile Screen
Adjustable from 69.7" to 57.9"
(Adjustable by 11.8")

BARRIERS

*All Glass comes in Lead or Acrylic (-AC)

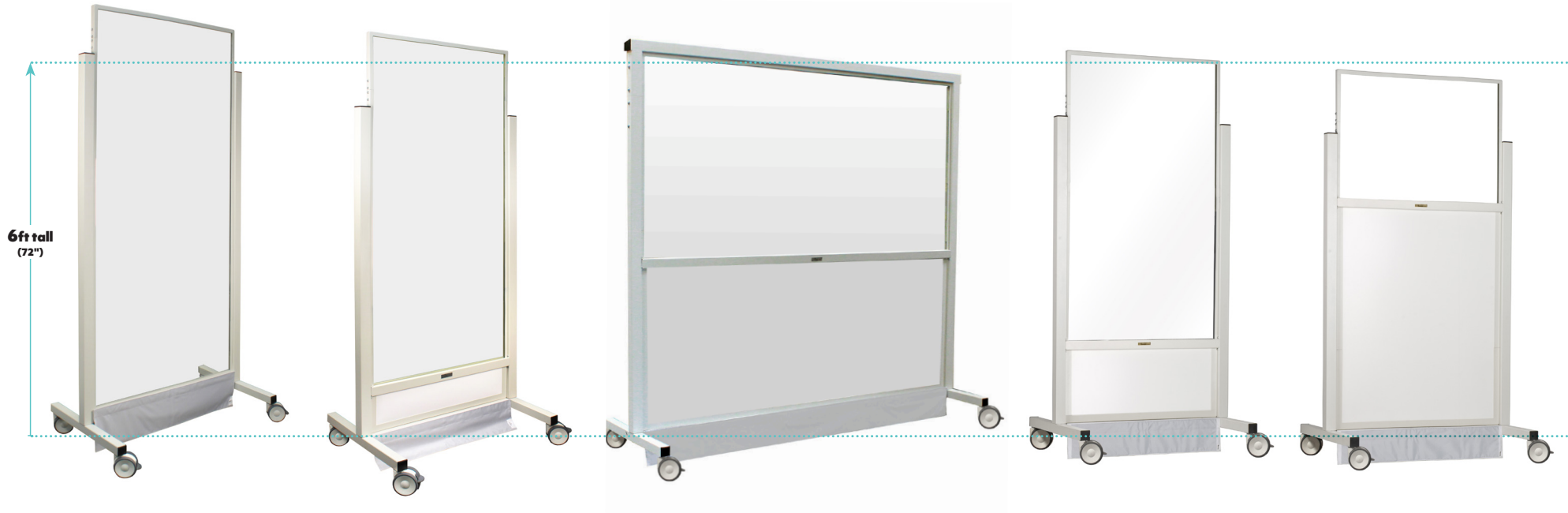

683492
Large Window
Mobile Barrier

SIZE: 80¼" H x 40½" W x 25"D
WINDOW: 72" H x 36" W

683476
X-Tall Mobile
Barrier

SIZE: 78¼" H x 40½" W x 25"D
WINDOW: 60" H x 36" W

683488
X-Wide Mobile
Barrier

SIZE: 74½" H x 76½" W x 25"D
WINDOW: 36" H x 72" W

683473
Mid-Tall Mobile
Barrier

SIZE: 74½" H x 34½" W x 25"D
WINDOW: 60" H x 30" W

683482
Wide Mobile
Barrier

SIZE: 72" H x 52½" W x 25"D
WINDOW: 36" H x 48" W



683465
Small Window
Mobile Barrier

SIZE: 72¼" H x 52½" W x 25"D
WINDOW: 12" H x 12" W

683468
Medium Window
Mobile Barrier

SIZE: 74" H x 52½" W x 25"D
WINDOW: 12" H x 24" W

683460
Standard Mobile
Barrier

SIZE: 72" H x 34½" W x 25"D
WINDOW: 24" H x 30" W

683484
Regular Mobile
Barrier

SIZE: 64½" H x 40½" W x 25"D
WINDOW: 24" H x 36" W

683458
"Shorty" Mobile
Barrier

SIZE: 45" H x 34½" W x 25"D
WINDOW: 24" H x 30" W

RACKS

Save Space + Increase Apron Life

INFAB offers apron racks for storing lead aprons used in healthcare facilities. These racks are sturdy and can hold multiple aprons, ensuring easy access for staff. They come in a variety of sizes and designs.



REV-MRK-10
Revolution 10 Arm
Mobile Apron Rack



683435
10 Hanger Mobile
Apron Valet



683438
20 Hanger Mobile
Apron Valet



683419
Mini Mobile Apron
Rack with Hangers

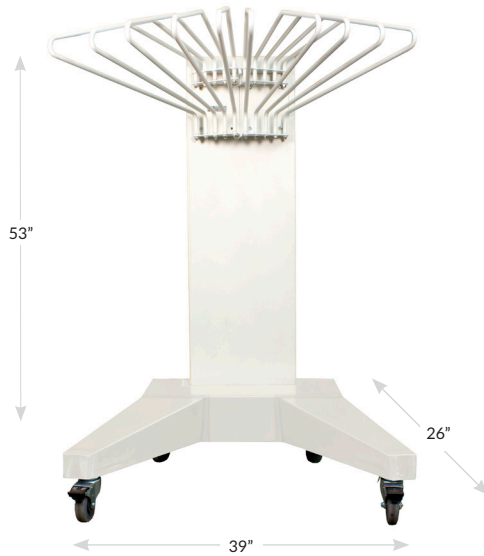

683407
Deluxe Mobile
Apron Rack



683426
5 Arm Budget Saver
Mobile Apron Rack



683427
10 Arm Budget Saver
Mobile Apron Rack

ACCESSORIES

Gloves, Cleaners, Disposables, + More

INFAB offers a variety of options for radiation protection gloves and cleaning solutions to meet your equipment cleaning needs. Our wide range of products allows you to choose the best solution for your specific task.



SPLIT PALM MITTENS WITH FLAP
18 Colors Available



MAXI-FLEX MITTENS
18 Colors Available

**REVOLUTION
MAXI-FLEX
5 FINGER LEAD GLOVES**

COLOR: Black, Red,
Blue (shown) and
15 additional colors



GLOVES

INFAB offers customizable gloves in various colors, styles, and lead equivalencies. Choose from reusable or disposable with heavy, medium, or light attenuation level rating.



**RADIATION PROTECTION
SURGICAL GLOVES**



**REVOLUTION
GLOVES**



**LEAD-FREE NEOPRENE RADIATION
PROTECTION GLOVES**

CLEANERS

INFAB's Scrubbles apron cleaner removes barium, blood, and other radiology stains while leaving behind a clean citrus scent. Additionally, Clorox Healthcare products are also available for cleaning and disinfection in healthcare facilities.



HEALTHCARE®

Infab is proud to be a global cleaning solutions partner with Clorox.

- No harsh chemical odor or fumes
- No fragrance added
- Nonflammable, unlike quaternary ammonium-alcohol-based wipes
- No volatile organic compounds (VOCs)



CASSETTE COVERS

Our cassette covers provide exceptional protection against contamination during radiographic process. They protect film, imaging plates and intensify screens.



Flip Top

or



Zip Top



Roll & Rack



Wall Mounted

Available in a Variety of Sizes



CURTAINS

INFAB's lead curtains are customizable and come in any size, color, or fabric. They have lead equivalency options of .25mm, .50mm, and .75mm.



Any Infab Classic Nylon Color



Straight Track



Curved Track

DENTAL

Our dental aprons protect patients and staff members with colorful designs and the ability to customize with patterns and logos.



DTL-ADULT
Dental Apron



DTL-PANO
Pano Cape
Dental Apron

PATIENT

Our eye, thyroid, ovarian, and gonad protective shields ensure optimal patient care during medical procedures.



PP-ES
Disposable Eye
Shields



PP-TS
Disposable Thyroid
Shield



HSV
Half Apron



683400
Patient Protection Set



684120
Ovarian Shields



PGS
Gonad Shields

Sterile Drapes

INFAB's sterile drapes are high-quality, sterilized materials for surgical procedures. They come in various sizes and design. They provide a barrier to reduce contamination and protect both the patient and equipment during surgical procedures.



MINI C ARM DRAPE



C ARM DRAPE



C ARM DRAPE KIT



FOOT SWITCH COVER

Contact Us
M-F 6:30am-5pm PDT
info@infabcorp.com
www.InfabCorp.com

Infab Corporation
1040 Avenida Acaso
Camarillo, CA, USA 93012
Phone: 805-987-5255
Fax: 805-482-8424

